

Presentation



LRD 08



LRD 365

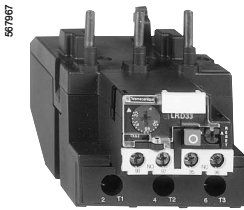

LRD 33●●

TeSys D thermal overload relays are designed to protect a.c. circuits and motors against:

- overloads,
- phase failure,
- excessively long starting times,
- prolonged stalled rotor condition.

Power connection

LRD 01 to LRD 35

LRD 01 to 35 relays are designed for connection by screw clamp terminals. They can be supplied for connection by spring terminals or by lugs (1).

LRD 313 to LRD 365

LRD 313 to 365 relays are for connection by BTR screw connectors (hexagon socket head).

The screws are tightened by means of a size 4, insulated Allen key. This type of connection uses the **EverLink®** system with creep compensation (2) (Schneider Electric patent). This technique makes it possible to achieve accurate and durable tightening torque.

These relays are also available for connection by lugs (1).

LRD 3361 to 4369, LR2 D3561 to D3563

LRD 3361 to 4369 and LR2 D3561 to D3563 relays are designed for connection by screw clamp terminals. They can be supplied for connection by lugs (1).

Description

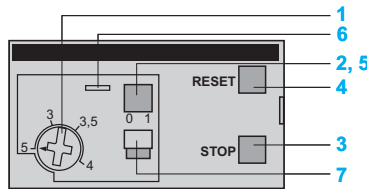

LRD 01...35 and LRD 313...LRD 365

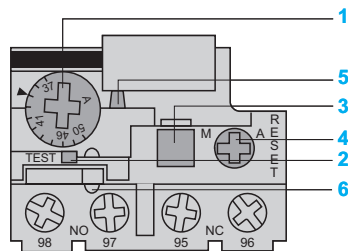

LRD 3361...4369, LR2 D3561...3563

TeSys D 3-pole thermal overload relays are designed to protect a.c. circuits and motors against overloads, phase failure, long starting times and prolonged stalling of the motor.

- 1 Adjustment dial I_r .
- 2 Test button.
Operation of the Test button allows:
 - checking of control circuit wiring,
 - simulation of relay tripping (actuates both the N/O and N/C contacts).
- 3 Stop button. Actuates the N/C contact; does not affect the N/O contact.
- 4 Reset button.
- 5 Trip indicator.
- 6 Setting locked by sealing the cover.
- 7 Selector for manual or automatic reset.

LRD 01 to 35 and LRD 313 to LRD 365 relays are supplied with the selector in the manual position, protected by a cover. Deliberate action is required to move it to the automatic position.

(1) Connection by lugs meets the requirements of certain Asian markets and is suitable for applications subject to strong vibration, such as railway transport.

(2) Creep: normal crushing phenomenon of copper conductors, that is accentuated over time.

Environment			
Conforming to standards			IEC/EN 60947-4-1, IEC/EN 60947-5-1, UL 508, CSA C22.2 n° 14. ATEX directive 94/9/EC (1)
Product certifications			UL, CSA, CCC, GOST ATEX INERIS (1). GL, DNV, RINA, BV, LROS (2).
Degree of protection	Conforming to VDE 0106		Protection against direct finger contact IP 2X
Protective treatment	Conforming to IEC 60068		"TH"
Ambient air temperature around the device	Storage	°C	- 60... + 70
	Normal operation, without derating (IEC 60947-4-1)	°C	- 20... + 60
	Minimum /maximum operating temperatures (with derating)	°C	- 40... + 70
Operating positions without derating	In relation to normal vertical mounting plane		Any position. When mounting on a vertical rail, use a stop.
Flame resistance	Conforming to UL 94		V1
	Conforming to IEC 60695-2-1	°C	850
Shock resistance	Permissible acceleration conforming to IEC 60068-2-7		15 gn - 11 ms
Vibration resistance (3)	Permissible acceleration conforming to IEC 60068-2-6		6 gn
Dielectric strength at 50 Hz	Conforming to IEC 60255-5	kV	6
Surge withstand	Conforming to IEC 60801-5	kV	6

Electrical characteristics of power circuit										
Relay type		LRD 01 ...16, LR3 D01 ...16	LRD 1508 ...1532	LRD 21 ...35, LR3 D21 ...35	LRD 313 ...365 LR3 D313 ...365	LRD 313L ...365L	LRD 3322 ...33696 LR3 D3322 ... 33696	LR2 D3522 ... 3563	LRD 4365 ...4369	
Tripping class	Conforming to UL 508, IEC 60947-4-1	10 A	20	10 A	10 A	20	10 A	20	10 A	
Rated insulation voltage (Ui)	Conforming to IEC 60947-4-1	V	690						1000	
	Conforming to UL, CSA	V	600						600 except LRD 4369	
Rated impulse withstand voltage (Uimp)		kV	6							
Frequency limits	Of the operating current	Hz	0...400							
Setting range	Depending on model	A	0.1...13	2.5...32	12...38	9...65	9...65	17...140	17...80	80...140

Auxiliary contact characteristics										
Conventional thermal current		A	5							
Max. sealed consumption of the operating coils of controlled contactors (Occasional operating cycles of contact 95-96)	a.c. supply, AC-15	V	120	240	380	480	500	600		
		A	3	1.5	0.95	0.75	0.72	0.12		
	d.c. supply, DC-13	V	125	250	440					
		A	0.22	0.1	0.06					
Protection against short-circuits	By gG, BS fuses. Maximum rating or by GB2	A	5							

(1) For relays LRD01 to LRD365.

(2) Pending for relays LRD313 to LRD365.

(3) For relays LRD 313 to LRD 365: 6 gn only with independent plate mounting and 4 gn when mounted beneath the contactor.

Power circuit connection characteristics										
Relay type			LRD 01 ...16, LR3 D01 ...16	LRD 1508 ...1532	LRD 21 ...35, LR3 D21 ...35	LRD 313 ...365 LR3 D313 ...365	LRD 313L ...365L	LRD 3322 ...33696 LR3 D3322 ... 33696	LR2 D3522 ...3563	LRD 4365 ...4369
Connection to screw clamp terminals										
Flexible cable without cable end	1 conductor	mm ²	1.5...10		1.5...10	1...35	1...35	4...35		4...50
Flexible cable with cable end	1 conductor	mm ²	1...4		1...6 except LRD 21: 1...4	1...35	1...35	4...35		4...35
Solid cable without cable end	1 conductor	mm ²	1...6		1.5/10 except LRD 21: 1/6	1...35	1...35	4...35		4...50
Tightening torque		N.m	1.7	1.85	2.5	1...25 : 5 35 : 8	1...25 : 5 35 : 8	9	9	9
Connection to spring terminals (Min/max c.s.a.)										
Flexible cable without cable end	1 conductor	mm ²	1.5...4	–	1.5...4	–	–	–	–	–
Flexible cable with cable end	1 conductor	mm ²	1.5...4	–	1.5...4	–	–	–	–	–
Connection by bars or lugs										
Relay type			LRD 016 ... 166	LRD 216 ... 356	LRD 3136 ... 3656	LRD 313L6 ... 365L6	LRD 3322A66 ... 3365A66			
Pitch	Without spreaders	mm	14.5	17.5	17.5	17.5	21.5			
Bars or cables with lugs	e	N.m	≤ 6	≤ 6	≤ 6	≤ 6	≤ 6			
	L	mm	≤ 8	≤ 8	≤ 13.5	≤ 13.5	≤ 16			
	L'	mm	≤ 9.5	≤ 10	≤ 16.5	≤ 16.5	≤ 16			
	d		≤ 7	≤ 7	≤ 10	≤ 10	≤ 12			
Screws			M4	M4	M6	M6	M10			
	Tightening torque	N.m	2.3	2.3	6	6	11.3			
Control circuit connection characteristics										
Connection to screw clamp terminals or spring terminals										
Bare cables										
Relay type			LRD 01 ...16, LR3 D01 ...16	LRD 1508 ... 1532	LRD 21 ...35, LR3 D21 ...35	LRD 313 ...365 LR3 D313 ...365	LRD 313L ...365L	LRD 3322 ...33696 LR3 D3322 ... 33696	LR2 D3522 ... 3563	LRD 4365 ...4369
Connection to screw clamp terminals (1)										
	Solid cable without cable end	mm ²	2 x 1...2.5							
	Flexible cable without cable end	mm ²	2 x 1...2.5							
	Flexible cable with cable end	mm ²	2 x 1...2.5							
Tightening torque		N.m	1.7							
Connection to spring terminals (Min/max c.s.a.)										
	Solid cable	mm ²	1...2.5	–	1...2.5		–			
	Flexible cable without cable end	mm ²	1...2.5	–	1...2.5		–			

(1) For relays LRD 313 to 365: BTR hexagon socket head screws, EverLink® system. In accordance with local electrical wiring regulations, a size 4 insulated Allen key must be used (reference LAD ALLEN4, see page 175).

Operating characteristics

Relay type		LRD 01 ...16, LR3 D01 ...16	LRD 1508 ... 1532	LRD 21 ...35, LR3 D21 ...35	LRD 313 ...365 LR3 D313 ...365	LRD 313L ...365L	LRD 3322 ...33696 LR3 D3322 ... 33696	LR2 D3522 ... 3563	LRD 4365 ...4369
Temperature compensation		°C		- 20... + 60					
Tripping threshold		Conforming to IEC 60947-4-1		A		1.14 ± 0.06 I _r			
Sensitivity to phase failure		Conforming to IEC 60947-4-1		Tripping current I 30 % of I _r on one phase, the others at I _r .					

Tripping curves

Average operating time related to multiples of the setting current

LRD 01 to LRD 35, LR2 D and LRD 3322 to LRD 4369

LRD 1508 to LRD 32 and LR2 D3522 to LR2 D3563

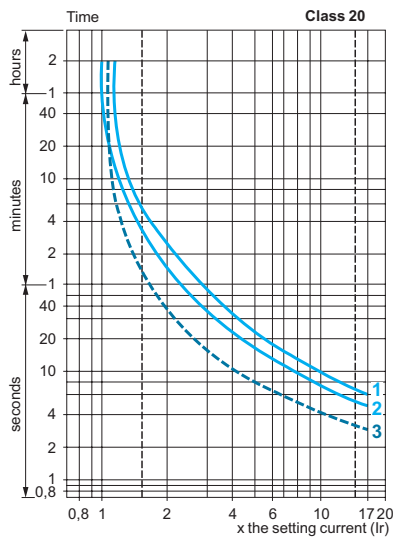
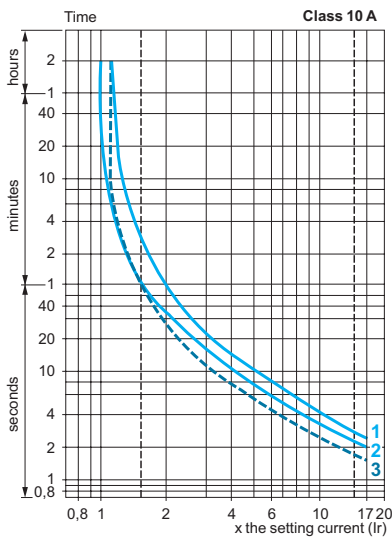

LRD 313 to LRD 365

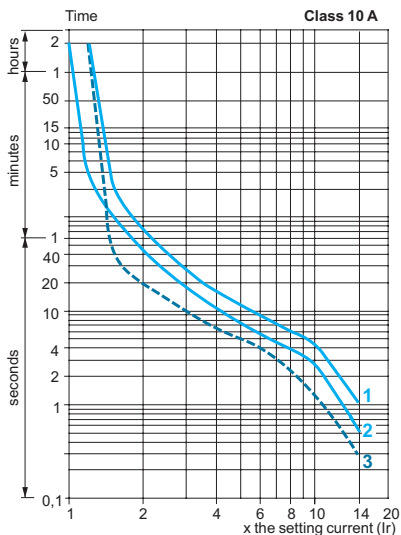

LRD 313L to LRD 365L

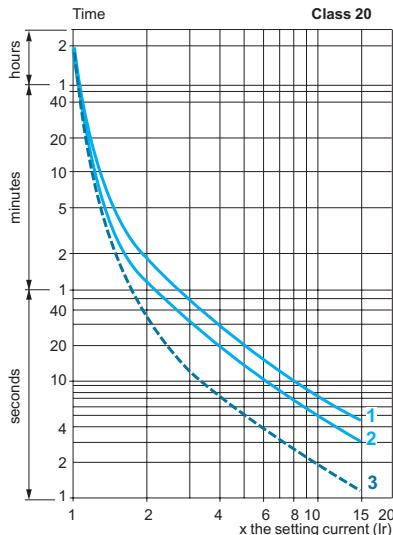

- 1 Balanced operation, 3-phase, without prior current flow (cold state).
- 2 2-phase operation, without prior current flow (cold state).
- 3 Balanced operation, 3-phase, after a long period at the set current (hot state).

Description

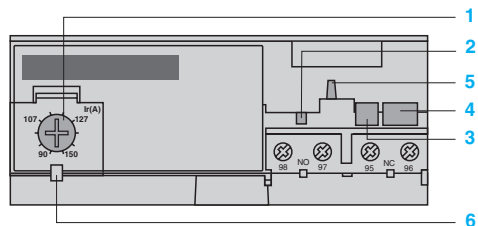

LR9 D5367...D5569

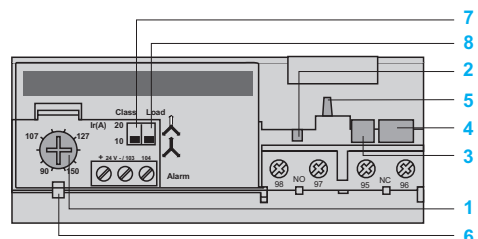

LR9 D67 and D69

LR9 D electronic thermal overload relays are designed for use with contactors LC1 D115 and D150.

In addition to the protection provided by TeSys D thermal overload relays (see page 205), they offer the following special features:

- protection against phase imbalance,
- choice of starting class,
- protection of unbalanced circuits,
- protection of single-phase circuits,
- alarm function to avoid tripping by load shedding.

- 1 Adjustment dial Ir.
- 2 Test button.
- 3 Stop button.
- 4 Reset button.
- 5 Trip indicator.
- 6 Setting locked by sealing the cover.
- 7 Class 10/class 20 selector switch.
- 8 Selector for balanced load /unbalanced load

Environment

Conforming to standards		IEC 60947-4-1, 255-8, 255-17, VDE 0660 and EN 60947-4-1	
Product certifications		UL 508 , CSA 22-2	
Degree of protection	Conforming to IEC 60529 and VDE 0106	IP 20 on front panel with protective covers LA9 D11570● or D11560●	
Protective treatment	Standard version	"TH"	
Ambient air temperature around the device (Conforming to IEC 60255-8)	Storage	°C	- 40...+ 85
	Normal operation	°C	- 20...+ 55 (1)
Maximum operating altitude	Without derating	m	2000
Operating positions without derating	In relation to normal vertical mounting plane	Any position	
Shock resistance	Permissible acceleration conforming to IEC 60068-2-7	13 gn - 11 ms	
Vibration resistance	Permissible acceleration conforming to IEC 60068-2-6	2 gn - 5...300 Hz	
Dielectric strength at 50 Hz	Conforming to IEC 60255-5	kV	6
Surge withstand	Conforming to IEC 61000-4-5	kV	6
Resistance to electrostatic discharge	Conforming to IEC 61000-4-2	kV	8
Immunity to radiated radio-frequency disturbances	Conforming to IEC 61000-4-3 and NF C 46-022	V/m	10
Immunity to fast transient currents	Conforming to IEC 61000-4-4	kV	2
Electromagnetic compatibility	Draft EN 50081-1 and 2, EN 50082-2	Meets requirements	

Electrical characteristics of auxiliary contacts

Conventional thermal current		A	5					
Max. sealed consumption of the operating coils of controlled contactors (Occasional operating cycles of contact 95-96)	a.c. supply	V	24	48	110	220	380	600
	d.c. supply	VA	100	200	400	600	600	600
		V	24	48	110	220	440	–
		W	100	100	50	45	25	–
Protection against short-circuits	By gG or BS fuses or by circuit-breaker GB2	A	5					
Cabling Flexible cable without cable end	1 or 2 conductors	mm²	Minimum c.s.a.: 1 Maximum c.s.a.: 2.5					
	Tightening torque	Nm	1.2					

(1) For operating temperatures up to 70 °C, please consult your Regional Sales Office.

Relay type		LR9 D	
Electrical characteristics of power circuit			
Tripping class	Conforming to UL 508, IEC 60947-4-1	A	10 or 20
Rated insulation voltage (Ui)	Conforming to IEC 60947-4-1	V	1000
	Conforming to UL, CSA	V	600
Rated impulse withstand voltage (Uimp)		Hz	8
Frequency limits	Of the operating current	Hz	50...60 (1)
Setting range	Depending on model	A	60...150
Power circuit connections	Width of terminal lug	mm	20
	Clamping screw		M8
	Tightening torque	N.m	18
Operating characteristics			
Temperature compensation		°C	- 20...+ 70
Tripping thresholds	Conforming to IEC 60947-4-1		
	Alarm	A	1.05 ± 0.06 In
	Trip	A	1.12 ± 0.06 In
Sensitivity to phase failure	Conforming to IEC 60947-4-1		Tripping in 4 s ± 20 % in the event of phase failure
Alarm circuit characteristics			
Rated supply voltage	d.c. supply	V	24
Supply voltage limits		V	17...32
Current consumption	No-load	mA	≤ 5
Switching capacity		mA	0...150
Protection	Short-circuit and overload		Self protected
Voltage drop	Closed state	V	≤ 2.5
Cabling	Flexible cable without cable end	mm ²	0.5...1.5
Tightening torque		N.m	0.45

(1) For other frequencies and for applications involving the use of these overload relays with soft starters or variable speed drives, please consult your Regional Sales Office.

LR9 D tripping curves

Tripping time in seconds

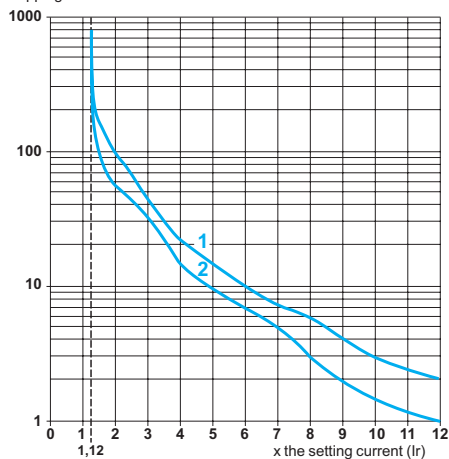

Average operating time related to multiples of the setting current

- 1 Cold state curve
- 2 Hot state curve



LRD 01



LRD 30

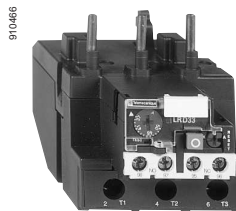

LRD 33



LRD 306

Differential thermal overload relays

for use with fuses or magnetic circuit-breakers GV2 L and GV3 L

- Compensated relays with manual or automatic reset,
- with relay trip indicator,
- for a.c. or d.c.

Relay setting range (A)	Fuses to be used with selected relay			For use with contactor LC1	Reference	Weight kg
	aM (A)	gG (A)	BS88 (A)			
Class 10 A (1) for connection by screw clamp terminals or connectors						
0.10...0.16	0.25	2	–	D09...D38	LRD 01	0.124
0.16...0.25	0.5	2	–	D09...D38	LRD 02	0.124
0.25...0.40	1	2	–	D09...D38	LRD 03	0.124
0.40...0.63	1	2	–	D09...D38	LRD 04	0.124
0.63...1	2	4	–	D09...D38	LRD 05	0.124
1...1.6	2	4	6	D09...D38	LRD 06	0.124
1.6...2.5	4	6	10	D09...D38	LRD 07	0.124
2.5...4	6	10	16	D09...D38	LRD 08	0.124
4...6	8	16	16	D09...D38	LRD 10	0.124
5.5...8	12	20	20	D09...D38	LRD 12	0.124
7...10	12	20	20	D09...D38	LRD 14	0.124
9...13	16	25	25	D12...D38	LRD 16	0.124
12...18	20	35	32	D18...D38	LRD 21	0.124
16...24	25	50	50	D25...D38	LRD 22	0.124
23...32	40	63	63	D25...D38	LRD 32	0.124
30...38	40	80	80	D32 and D38	LRD 35	0.124
Class 10 A (1) for connection by EverLink® BTR screw connectors (3)						
9...13	16	25	25	D40A...D65A	LRD 313	0.375
12...18	20	32	35	D40A...D65A	LRD 318	0.375
17...25	25	50	50	D40A...D65A	LRD 325	0.375
23...32	40	63	63	D40A...D65A	LRD 332	0.375
30...40	40	80	80	D40A...D65A	LRD 340	0.375
37...50	63	100	100	D40A...D65A	LRD 350	0.375
48...65	63	100	100	D50A and D65A	LRD 365	0.375
Class 10 A (1) for connection by screw clamp terminals or connectors						
17...25	25	50	50	D80 and D95	LRD 3322	0.510
23...32	40	63	63	D80 and D95	LRD 3353	0.510
30...40	40	100	80	D80 and D95	LRD 3355	0.510
37...50	63	100	100	D80 and D95	LRD 3357	0.510
48...65	63	100	100	D80 and D95	LRD 3359	0.510
55...70	80	125	125	D80 and D95	LRD 3361	0.510
63...80	80	125	125	D80 and D95	LRD 3363	0.510
80...104	100	160	160	D80 and D95	LRD 3365	0.510
80...104	125	200	160	D115 and D150	LRD 4365	0.900
95...120	125	200	200	D115 and D150	LRD 4367	0.900
110...140	160	250	200	D150	LRD 4369	0.900
80...104	100	160	160	(2)	LRD 33656	1.000
95...120	125	200	200	(2)	LRD 33676	1.000
110...140	160	250	200	(2)	LRD 33696	1.000

Class 10 A (1) for connection by lugs

Select the appropriate overload relay with screw clamp terminals or connectors from the table above and add one of the following suffixes:

- figure 6 for relays LRD 01 to LRD 35 and relays LRD 313 to LRD 365.
- **A66** for relays LRD 3322 to LRD 3365.

Relays LRD 4300 are suitable, as standard, for use with lug-clamps.

Thermal overload relays for use with unbalanced loads

Class 10 A (1) for connection by screw clamp terminals or lugs

In the references selected above, change the prefix LRD (except LRD 4000) to LR3 D.

Example: **LRD 01** becomes **LR3 D01**.

Example with EverLink® connectors: **LRD 340** becomes **LR3 D340**.

Example with lugs: **LRD 3406** becomes **LR3 D3406**.

(1) Standard IEC 60947-4-1 specifies a tripping time for 7.2 times the setting current I_R :

class 10 A: between 2 and 10 seconds

(2) Independent mounting of the contactor.

(3) BTR screws: hexagon socket head. In accordance with local electrical wiring regulations, a size 4 insulated Allen key must be used (reference **LAD ALLEN4**, see page 175).



LRD ●●3

Differential thermal overload relays

for use with fuses or magnetic circuit-breakers GV2 L and GV3 L

- Compensated relays with manual or automatic reset,
- with relay trip indicator,
- for a.c. or d.c.

Relay setting range (A)	Fuses to be used with selected relay			For use with contactor LC1	Reference	Weight kg
	aM (A)	gG (A)	BS88 (A)			
Classes 10 A (1) for connection by spring terminals (only for direct mounting beneath the contactor)						
0.10...0.16	0.25	2	–	D09...D38	LRD 013	0.140
0.16...0.25	0.5	2	–	D09...D38	LRD 023	0.140
0.25...0.40	1	2	–	D09...D38	LRD 033	0.140
0.40...0.63	1	2	–	D09...D38	LRD 043	0.140
0.63...1	2	4	–	D09...D38	LRD 053	0.140
1...1.6	2	4	6	D09...D38	LRD 063	0.140
1.6...2.5	4	6	10	D09...D38	LRD 073	0.140
2.5...4	6	10	16	D09...D38	LRD 083	0.140
4...6	8	16	16	D09...D38	LRD 103	0.140
5.5...8	12	20	20	D09...D38	LRD 123	0.140
7...10	12	20	20	D09...D38	LRD 143	0.140
9...13	16	25	25	D12...D38	LRD 163	0.140
12...18	20	35	32	D18...D38	LRD 213	0.140
16...24	25	50	50	D25...D38	LRD 223	0.140

Class 10 A with connection by EverLink® BTR screw connectors (2) and control by spring terminals

9...13	16	25	25	D40A...D65A	LRD 3133	0.375
12...18	20	32	35	D40A...D65A	LRD 3183	0.375
17...25	25	50	50	D40A...D65A	LRD 3253	0.375
23...32	40	63	63	D40A...D65A	LRD 3323	0.375
30...40	40	80	80	D40A...D65A	LRD 3403	0.375
37...50	63	100	100	D40A...D65A	LRD 3503	0.375
48...65	63	100	100	D50A and D65A	LRD 3653	0.375

Thermal overload relays for use with unbalanced loads

Classes 10 A (1) for connection by BTR screw connectors (2) and control by spring terminals

In the references selected above, replace **LRD 3** with **LR3 D3**.

Example: **LRD 3653** becomes **LR3 D3653**.

Thermal overload relays for use on 1000 V supplies

Classes 10 A (1) for connection by screw clamp terminals

For relays LRD 06 to LRD 35 only, for an operating voltage of 1000 V, and only for independent mounting, the reference becomes **LRD 33●●A66**.

Example: **LRD 12** becomes **LRD 3312A66**.

Order an **LA7 D3064** terminal block separately, see page 213.

(1) Standard IEC 60947-4-1 specifies a tripping time for 7.2 times the setting current I_R :

class 10 A: between 2 and 10 seconds

(2) BTR screws: hexagon socket head. In accordance with local electrical wiring regulations, a size 4 insulated Allen key must be used (reference **LAD ALLEN4**, see page 175).



LRD 15●●



LRD 3●●L



LR2 D35●●

Differential thermal overload relays

for use with fuses or magnetic circuit-breakers GV2 L and GV3 L

- Compensated relays with manual or automatic reset,
- with relay trip indicator,
- for a.c. or d.c.

Relay setting range (A)	Fuses to be used with selected relay			For use with contactor LC1	Reference	Weight kg
	aM (A)	gG (A)	BS88 (A)			
Classes 20 (1) for connection by screw clamp terminals						
2.5...4	6	10	16	D09...D32	LRD 1508	0.190
4...6	8	16	16	D09...D32	LRD 1510	0.190
5.5...8	12	20	20	D09...D32	LRD 1512	0.190
7...10	16	20	25	D09...D32	LRD 1514	0.190
9...13	16	25	25	D12...D32	LRD 1516	0.190
12...18	25	35	40	D18...D32	LRD 1521	0.190
17...25	32	50	50	D25 and D32	LRD 1522	0.190
23...28	40	63	63	D25 and D32	LRD 1530	0.190
25...32	40	63	63	D25 and D32	LRD 1532	0.190
Class 20 (1) for connection by EverLink® BTR screw connectors (2)						
9...13	20	32	35	D40A...D65A	LRD 313L	0.375
12...18	25	40	40	D40A...D65A	LRD 318L	0.375
17...25	32	50	50	D40A...D65A	LRD 325L	0.375
23...32	40	63	63	D40A...D65A	LRD 332L	0.375
30...40	50	80	80	D40A...D65A	LRD 340L	0.375
37...50	63	100	100	D40A...D65A	LRD 350L	0.375
48...65	80	125	125	D50A and D65A	LRD 365L	0.375
Classes 20 (1) for connection by screw clamp terminals						
17...25	32	50	50	D80 and D95	LR2 D3522	0.535
23...32	40	63	63	D80 and D95	LR2 D3553	0.535
30...40	40	100	80	D80 and D95	LR2 D3555	0.535
37...50	63	100	100	D80 and D95	LR2 D3557	0.535
48...65	80	125	100	D80 and D95	LR2 D3559	0.535
55...70	100	125	125	D80 and D95	LR2 D3561	0.535
63...80	100	160	125	D80 and D95	LR2 D3563	0.535

(1) Standard IEC 60947-4-1 specifies a tripping time for 7.2 times the setting current I_R :
class 20: between 6 and 20 seconds

(2) BTR screws: hexagon socket head. In accordance with local electrical wiring regulations, a size 4 insulated Allen key must be used (reference **LAD ALLEN4**, see page 175).

Differential thermal overload relays

for use with fuses or magnetic circuit-breakers NSX

- Compensated relays, with relay trip indicator,
- for a.c.,
- for direct mounting on contactor or independent mounting(1).

Relay setting range (A)	Fuses to be used with selected relay		For mounting beneath contactor LC1	Reference	Weight kg
	aM (A)	gG (A)			
Classes 10 or 10A (2) for connection using bars or connectors					
60...100	100	160	D115 and D150	LR9 D5367	0.885
90...150	160	250	D115 and D150	LR9 D5369	0.885
Classes 20 (2) for connection using bars or connectors					
60...100	125	160	D115 and D150	LR9 D5567	0.885
90...150	200	250	D115 and D150	LR9 D5569	0.885

Electronic thermal overload relays for use with balanced or unbalanced loads

- Compensated relays,
- with separate outputs for alarm and tripping.

Relay setting range (A)	Fuses to be used with selected relay		For mounting beneath contactor LC1	Reference	Weight kg
	aM (A)	gG (A)			
Classes 10 or 20 (2) selectable, for connection using bars or connectors					
60...100	100	160	D115 and D150	LR9 D67	0.900
90...150	160	250	D115 and D150	LR9 D69	0.900

(1) Power terminals can be protected against direct finger contact by the addition of shrouds and/or insulated terminal blocks, to be ordered separately (see page 174).

(2) Standard IEC 60947-4-1 specifies a tripping time for 7.2 times the setting current I_R :
 class 10: between 4 and 10 seconds,
 class 10 A: between 2 and 10 seconds,
 class 20 A: between 6 and 20 seconds

Other versions

Thermal overload relays for resistive circuits in category AC-1.
 Please consult your Regional Sales Office.

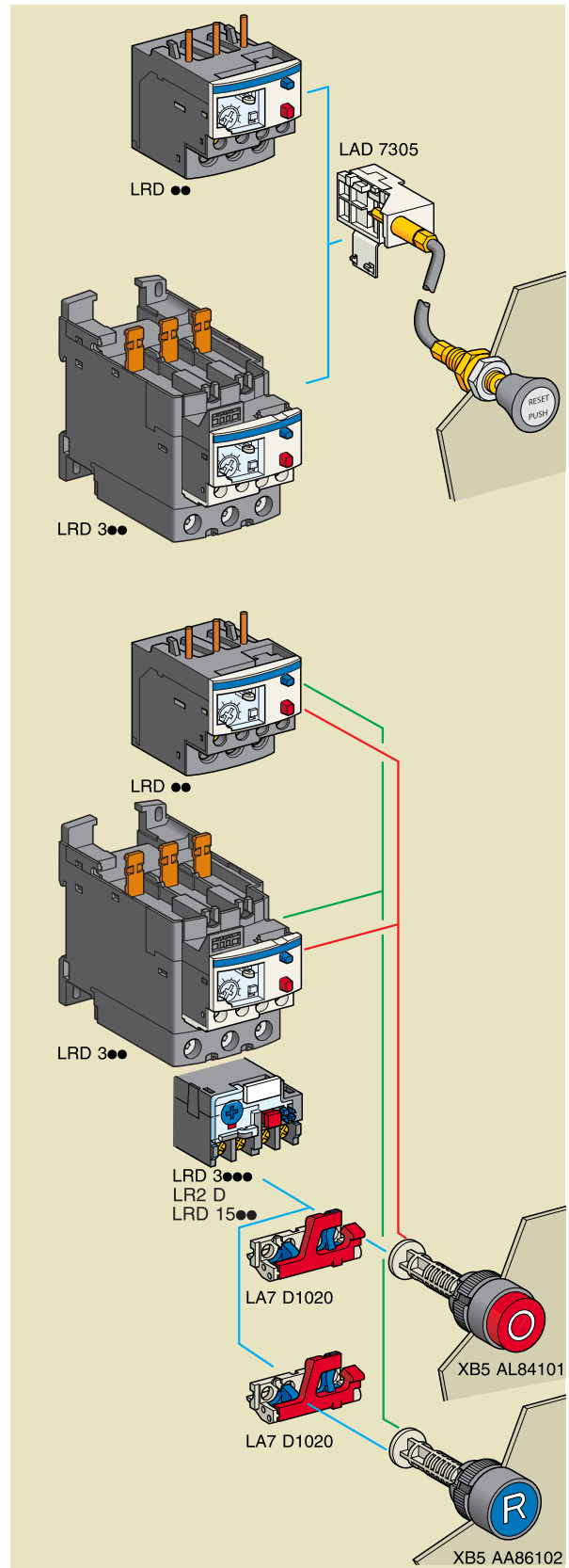
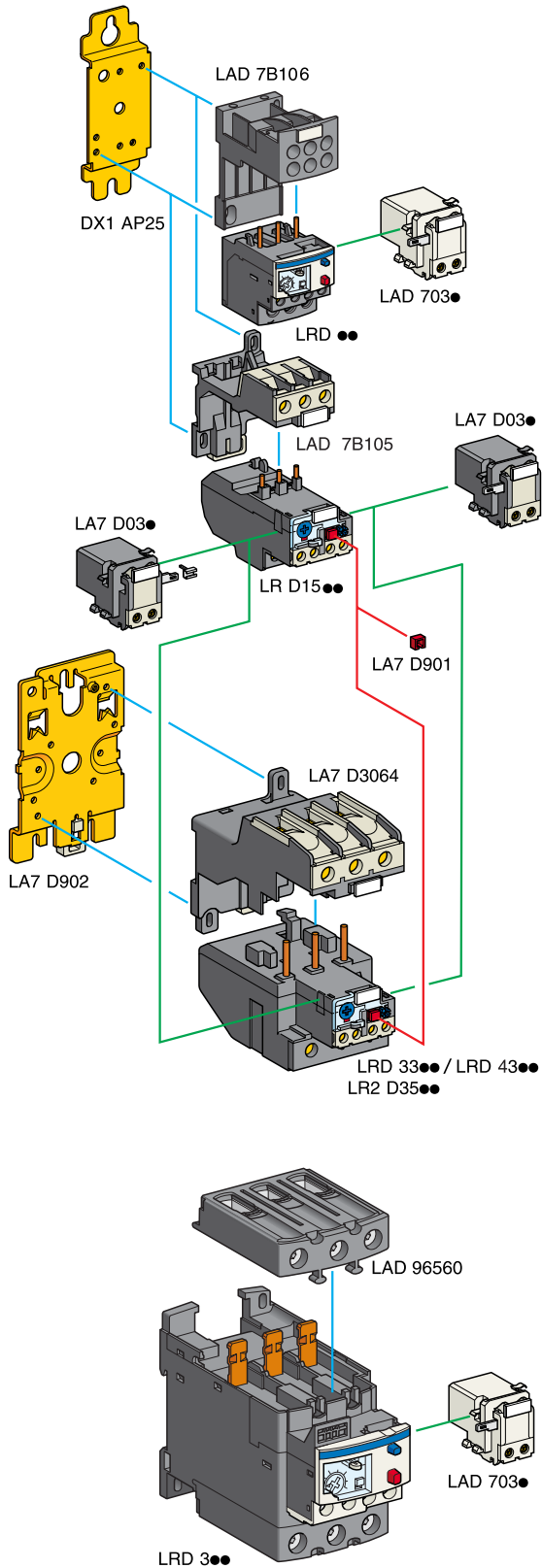

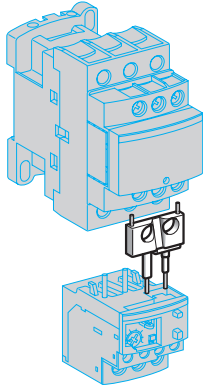

LAD 7C●

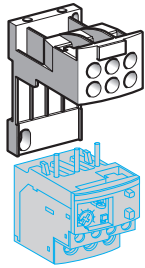

LAD 7B106

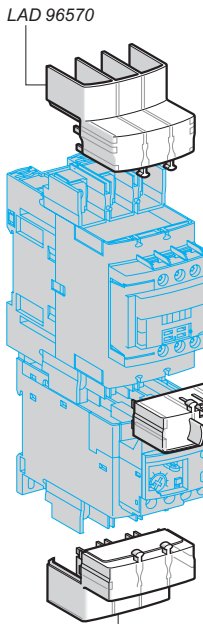

LAD 96570

LAD 96575

Separate components for relays

Description	For use with	Sold in lots of	Unit reference	Weight kg
Pre-wiring kit allowing direct connection of the N/C contact of relay LRD 01...35 or LR3 D01...D35 to the contactor	LC1 D09...D18	10	LAD 7C1 (1)	0.002
	LC1 D25...D38	10	LAD 7C2 (1)	0.003
Terminal block (2) for clip-on mounting on 35 mm rail (AM1 DP200) or screw fixing; for fixing centres, see pages 214 to 216	LRD 01...35 and LR3 D01...D35	1	LAD 7B106	0.100
	LRD 1508...32	1	LAD 7B105	0.100
EverLink® terminal block for independent mounting	LRD 33●●, LR3 D33●●●, LR2 D35●●	1	LAD 7D3064 (3)	0.370
Size 4 Allen key, insulated, 1000 V	LRD 3●●, LRD 3●●L and LR3 D3●●	5	LAD ALLEN4	0.026
Terminal block adapter for mounting a relay beneath an LC1 D115 or D150 contactor	LRD 3●●, LR3 D3●●●, LRD 35●●	1	LA7 D3058 (3)	0.080
Mounting plates (4) for screw fixing on 110 mm centres	LRD 01...35, LR3 D01...D35, LRD 1508...32	10	DX1 AP25	0.065
	LRD 3●●●, LR3 D3●●●, LR2 D35●●	1	LA7 D902	0.130
Marker holders, snap-in 8 x 18 mm	LRD 3●●	100	LAD 90	0.001
	All relays except LRD 01...35, LR3 D01...D35, LRD 3●●, LRD 3●●L and LR3 D3●●	100	LA7 D903	0.001
	All relays	1	LA9 D91	0.001
Bag of 400 blank legends (self-adhesive, 7 x 16 mm)	All relays	1	LA9 D91	0.001
Stop button locking device	All relays except LRD 01...35, LR3 D01...D35, LR9 D and LRD 313...LRD 365	10	LA7 D901	0.005
Remote Stop or electrical reset device (5)	LRD 01...35, LR3 D01...D35 and LRD 313...LRD 365	1	LAD 703● (6) (7)	0.090
Remote tripping or electrical reset device (5)	All relays except LRD 01...35, LR3 D01...D35, LRD 3●●, LRD 3●●L and LR3 D3●●	1	LA7 D03● (6)	0.090
Block of insulated terminals	LR9 D	2	LA9 F103	0.560
IP 20 cover for lug type terminals for independent mounting	LRD 3136...3656	1	LAD 96570	0.021
IP 20 cover for lug type terminals for mounting with contactor LC1 D40A6...D65A6	LRD 3136...3656	1	LAD 96575	0.010
Terminal block for lug type terminals for independent mounting	LRD 3136...3656	1	LAD 96566	0.010

Remote control

"Reset" function

Description	For use with	Sold in lots of	Unit reference	Weight kg
By flexible cable (length = 0.5 m)	LRD 01...35, LR3 D01...D35 and LRD 313...LRD 365	1	LAD 7305 (7)	0.075
	All relays except LRD 01...35, LR3 D01...D35, LRD 3●●, LRD 3●●L and LR3 D3●●	1	LA7 D305	0.075

"Stop" and/or "Reset" functions

The terminal protection shroud must be removed and the following 3 products must be ordered separately:

Adapter for door mounting	LRD 33●●, LR2 D and LRD 15●●.	1	LA7 D1020	0.005	
Operating heads for spring return pushbutton	Stop	All relays	1	XB5 AL84101	0.027
	Reset	All relays	1	XB5 AA86102	0.027

- (1) These pre-wiring kits cannot be used with reversing contactors.
- (2) Terminal blocks are supplied with terminals protected against direct finger contact and screws in the open, "ready-to-tighten" position.
- (3) To order a terminal block for connection by lugs, the reference becomes LA7 D30646.
- (4) Remember to order the terminal block corresponding to the type of relay.
- (5) The time for which the coil of remote tripping or electrical resetting device LA7 D03 or LAD 703 can remain energised depends on its rest time: 1 s pulse duration with 9 s rest time; 5 s pulse duration with 30 s rest time; 10 s pulse duration with 90 s rest time; maximum pulse duration 20 s with a rest time of 300 s. Minimum pulse time: 200 ms.
- (6) Reference to be completed by adding the code indicating the control circuit voltage.
Standard control circuit voltages (for other voltages, please consult your Regional Sales Office) :

Volts	12	24	48	96	110	220/230	380/400	415/440
50/60 Hz	—	B	E	—	F	M	Q	N
Consumption, inrush and sealed: < 100 VA								
---	J	B	E	DD	F	M	—	—

Consumption, inrush and sealed: < 100 W.

(7) Not compatible with 3-pole relays fitted with spring terminals.

LRD 01...35

Direct mounting beneath contactors with screw clamp connections

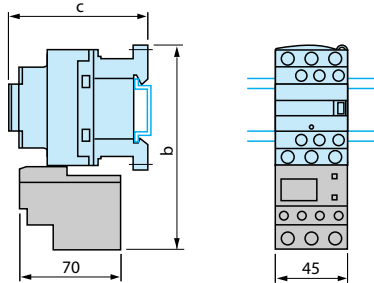

LRD 1508...32

Direct mounting beneath contactors with screw clamp connections

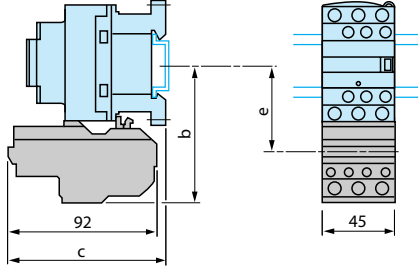

LRD 013...223

Direct mounting beneath contactors with spring terminal connections

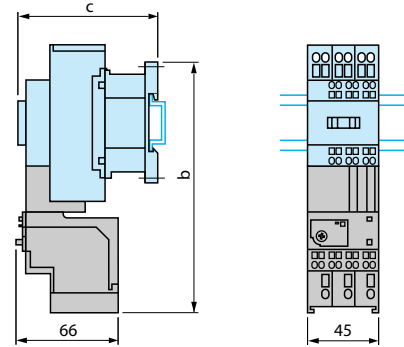

LC1	D09...D18	D25...D38
b	123	137
c	See pages 182 and 183	

LC1	~ D09... D18	~ D25... D38	~ D09... D18	~ D25... D38
b	90	97	90	97
c	97	96	107	106
e	53	60	53	60

LC1	D093...D253
b	168
c	See pages 182 and 183

LRD 313 ...365

Direct mounting beneath contactors LC1 D40A...D65A with screw clamp connections or EverLink® connectors

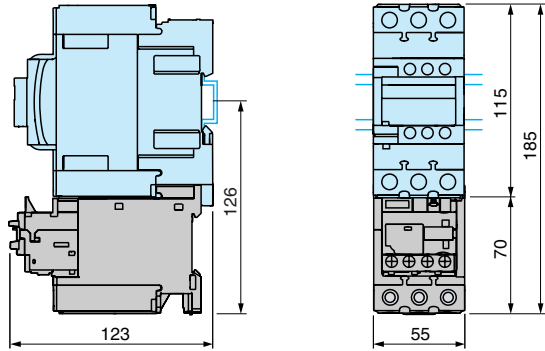

LRD 3136 ...3656

Direct mounting beneath contactors LC1 D40A6...D65A6 with lugs

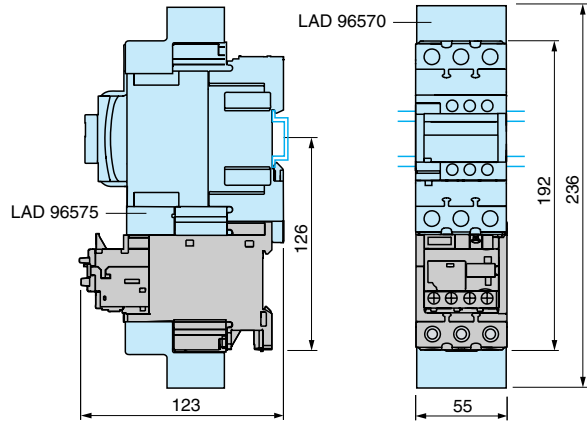

LRD 4...

Direct mounting beneath contactors LC 1D115 and D150

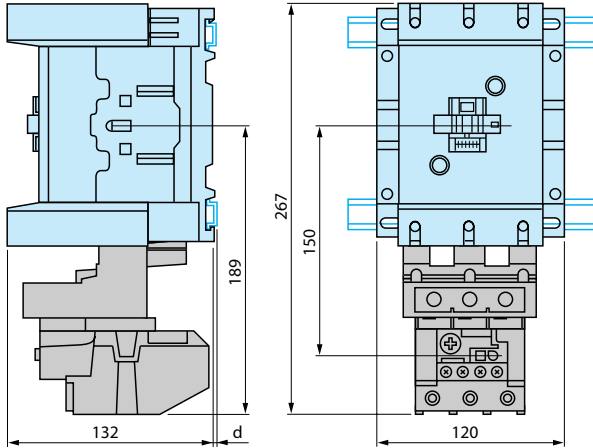

AM1	DL200 and DR200	DE200 and ED...
d	2.5	10.5

LR9 D

Direct mounting beneath contactors LC 1D115 and D150

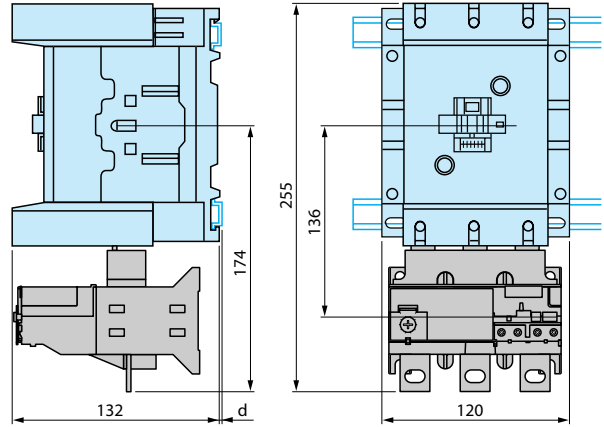

AM1	DP200 and DR200	DE200 and ED...
d	2.5	10.5

LRD 01...35

Independent mounting on 50 mm centres or on rail AM1 DP200 or DE200

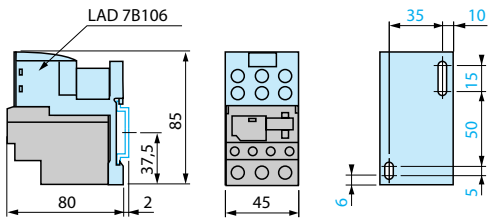

Independent mounting on 110 mm centres

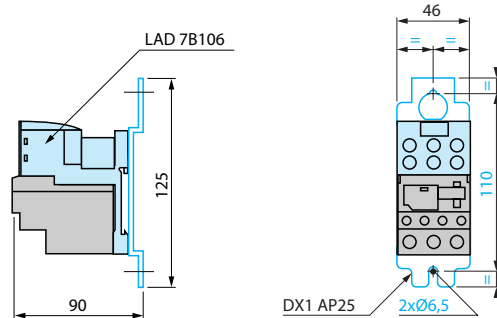

LRD 313...365

Mounting on rail AM1 D200 or ED200

With terminal block LAD 96560

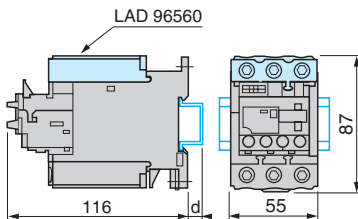

AM1	DP200	DE200	ED200
d	2	9.5	9.5

Panel mounting

Outgoing terminal block not shown

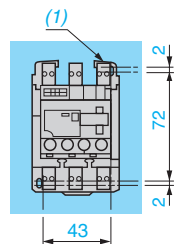

(1) 2 elongated holes Ø 4.2 x 6.

Mounted on plate AM1 P

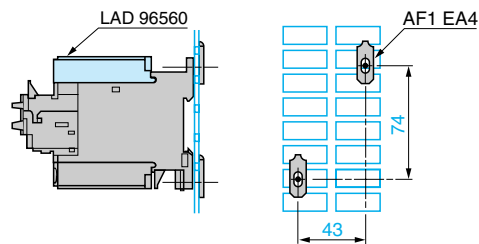

LRD 01...35 and LRD 313...365

Remote tripping or electrical reset

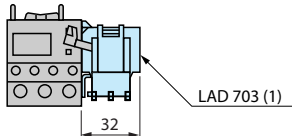

(1) Can only be mounted on RH side of relay LRD01...35 and LRD313...365

LRD 15●●

Independent mounting on 50 mm centres or on rail AM1 DP200 or DE200

Remote tripping or electrical reset

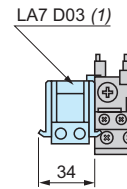
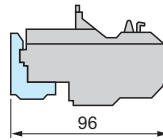
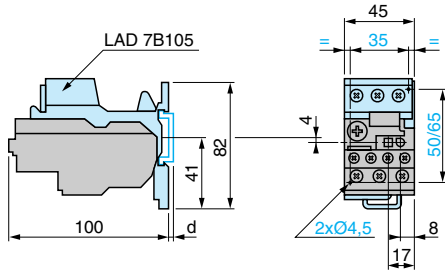

AM1	DP200	DE200
d	2	9.5

d

(1) Can be mounted on RH or LH side of relay LR2 D15.

LRD 3●●● and LR2 D35●●

Independent mounting on 50 mm centres or on rail AM1 DP200 or DE200

LRD 3●●●, LR2 D35●● and LR9 D

Remote tripping or electrical reset

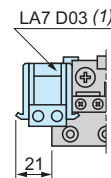
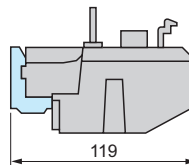
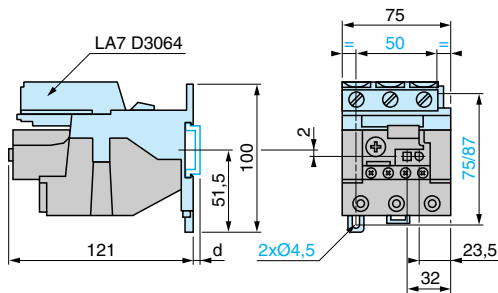

AM1	DP200	DE200
d	2	9.5

d

(1) Can be mounted on RH or LH side of relay LRD 3●●●, LR2 D35●● or LR9 D.

LRD 15 and LRD 3●●●

Adapter for door mounted operator

LA7 D1020

Stop

Reset

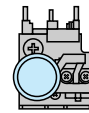
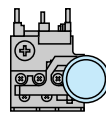
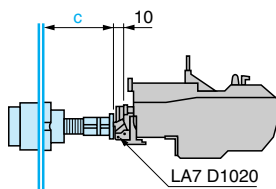

c : adjustable from 17 to 120 mm

LRD, LRD 313...365, LRD 15 and LR9 D

"Reset" by flexible cable

LA7 D305 and LAD 7305

Mounting with cable straight

Mounting with cable bent

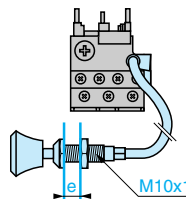
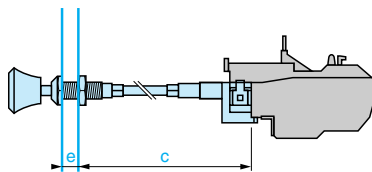

e : up to 20 mm
c : up to 550 mm

e : up to 20 mm